

# Decorative Curtain Poles





## Cord Operated Curtain Pole System

# Silent Gliss® 6160M Metropole

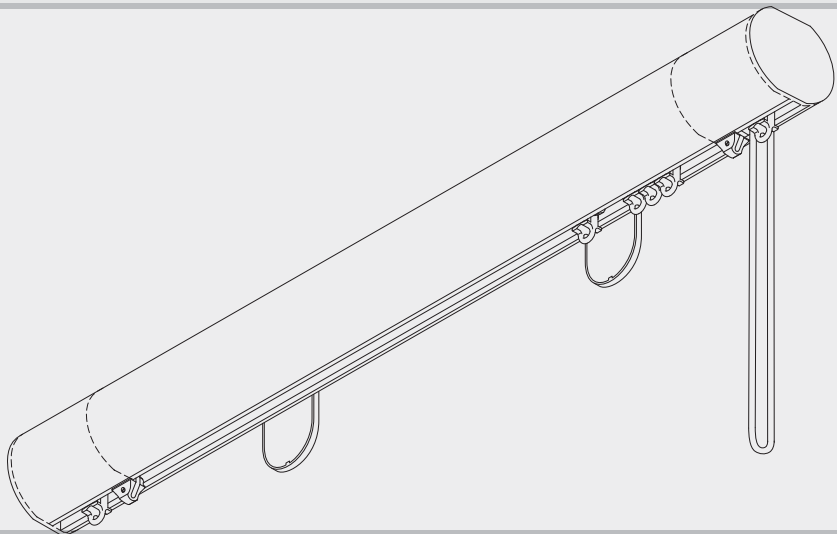

### Product Information

- Cord operated system for domestic and contract applications
- 6160M can be bent for bay windows etc
- For light to medium weight curtains
- Made to measure
- Choice of 8 different finishes - anodic grey, black, white, matt white, ecru, slate grey, taupe and antique bronze
- Accessorised with matching endsets and brackets
- A selection of finials are available
- Easy fit with wall and ceiling brackets
- Suitable for use with Wave Standard curtain heading system
- Maximum profile length 6m

6160M

## Profile, Bending and Specification Information

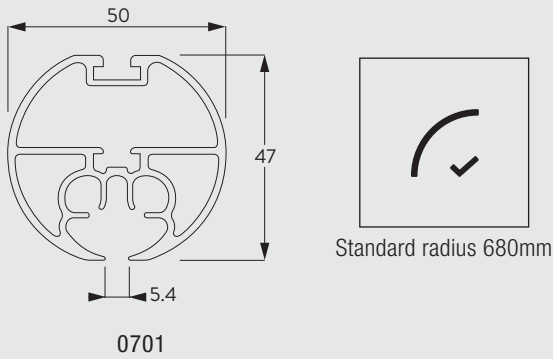

Specification Information - for download refer to [www.silentgliss.co.uk](http://www.silentgliss.co.uk) (password required).

Silent Gliss 6160M curtain track, cord drawn, aluminium, assembled with gliders 6143 10/m. Metal overlap arm 6003, cord set 0347, cord 3091, end caps 0350, pilot 6534 and endstops 6065. Face fix with bracket 0537/ 3134/2-36/2/ 0334/top fix with bracket 6138P2/ 0335 each screwed to timber/plugged and screwed to block/concrete at 600mm centres. Finished in anodized grey, black, white, matt white, ecru, slate grey, taupe or antique bronze.

## How to Measure

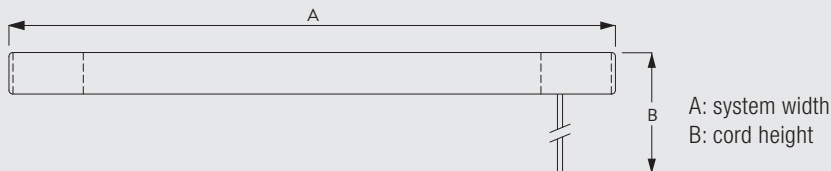

## Stack size calculation Wave Standard

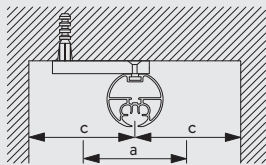
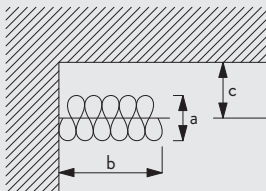

a = Stack depth  
b = Stack size  
c = Min. distance

Glider-cord spacing	Curtain hook spacing	Approx. curtain fullness	Stack depth (a)	Stack width (b)	Min distance (c)
6	10	2.1	10	23 per metre of track + endpiece	8
6	12	2.3	12	23 per metre of track + endpiece	9
8	14	2.1	14	18 per metre of track + endpiece	10
8	16	2.3	16	18 per metre of track + endpiece	11

Wave standard with roller gliders











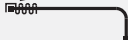
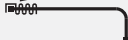
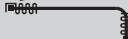
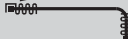

Glider-cord spacing	Curtain hook spacing	Approx. curtain fullness	Stack depth (a)	Stack width (b)	Min distance (c)
8	14	2.1	14	21 per metre of track + endpiece	10
8	16	2.3	16	21 per metre of track + endpiece	11

(dimensions in cm)

Note: Minimum distance (c) allows a standard 3cm clearance (front and back).

## System Dimensions

### Maximum curtain weights

	Standard Application with Glider						Standard Application with Roller/ Wave Roller						
	1 m	2 m	3 m	4 m	5 m	6 m	1 m	2 m	3 m	4 m	5 m	6 m	
	9	9	8	8	7	7		12	11	11	11	10	10
	10	10	9	9	8	8		13	13	12	11	11	10
	7	7	6	6	5	5		9	8	8	8	7	7
	8	8	7	7	6	6		10	9	9	9	8	8
	4	4	3	3	2	2		6	5	5	5	4	4
	5	5	4	4	3	3		7	6	6	6	5	5
	3	3	2	2	1	1		5	4	4	4	3	3
	4	4	3	3	2	2		6	5	5	5	4	4

(kg max.) (kg max.)

### Wave maximum curtain weights

Maximum curtain weight when using Wave curtain heading is 2.5kg/m unless the weight in the above left table is less in which case follow table. A greater weight may be achieved using wave roller glider 6098W (refer to table above right).

## Design Options

### Endcaps

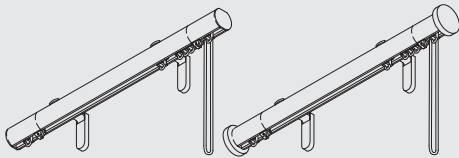

Without finials, poles are supplied as standard with flush fitting endcaps 0350 (left). Alternatively, stud endcaps 0714 (right) can be selected at no additional cost.

6160M

### Finials

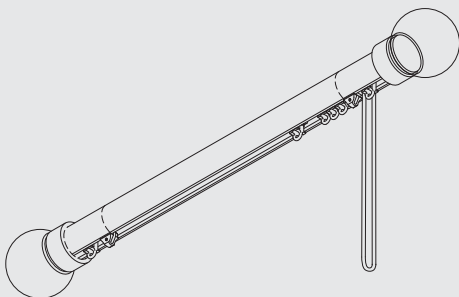

Finials are decorative elements that fit on at the end of the pole.

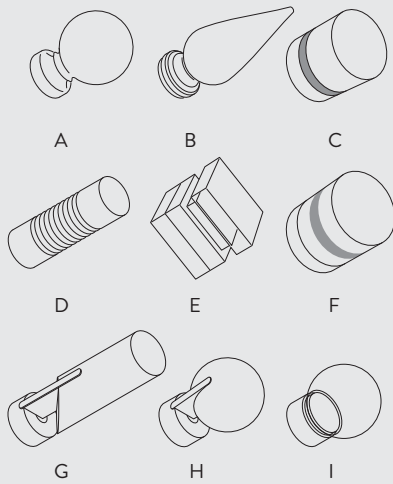

- A: 0717 Ball End 125mm
- B: 0718 Real Wood Spear 150mm
- C: 0697 Strata 65mm
- D: 0630 Groove Cylinder 125mm
- E: 0898 Crystal Cube 55mm
- F: 0899 Crystal Cylinder 55mm
- G: Fused Barrel 121mm (walnut/oak/matched)
- H: Fused Ball 81mm (walnut/oak/matched)
- I: Glass Ball (clear/frosted) 70mm

Please refer to the Metropole brochure for full range details.

### Wave Standard curtain heading system

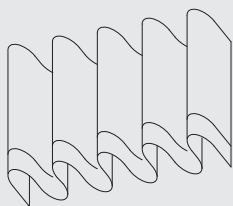

Wave Standard is an exciting new contemporary heading system which allows curtains to hang in a continuous wave which is smooth, simple and elegant.

When using the Wave curtain heading system please note the maximum recommended curtain weight is 2.5kg/m. A greater weight may be achieved using wave roller glider 6098W (refer to 'System Dimensions').

The Wave standard components are:

- 6345 Glider Cord 60mm
- 6346 Glider Cord 80mm
- 6007 End stop

The items listed below for Enhanced Wave (80mm glider cord only) are all supplied at an additional cost as per the price list.

- 2255 Adjustable brake
- 6364 Extension (for use with 6365)
- 6365 Hanger (for use with 6364)
- 6366 Carrier for draw rod

Roller gliders must be ordered separately  
6098W Wave roller glider 80mm

Optional enhanced components to improve the presentation of the curtain:

- 3582 Hook
- 6349 Curtain tape
- 6363 Iron-on top hemming tape
- 10075 Lead weight for bottom hem 50gr/m
- 10076 Fabric weight for side of curtain

6160M

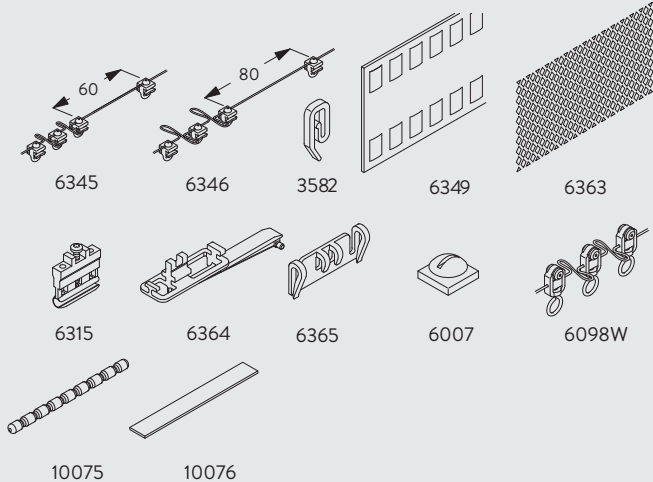

## Fitting Information

### WARNING

Young children can be strangled by loops in pullcords, chains, tapes and inner cords that operate the product. To avoid strangulation and entanglement, keep cords out of the reach of young children. Cords may become wrapped around a child's neck. Move beds, cots and furniture away from window covering cords. Do not tie cords together. Make sure cords do not twist to create a loop.

### Bracket positioning

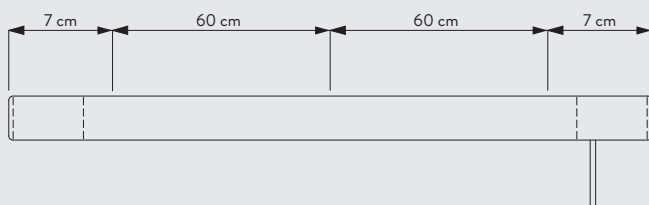

An additional bracket may be required near the 'cord-end' of the system if the system is carrying very heavy curtains.

### Fitting of track to bracket

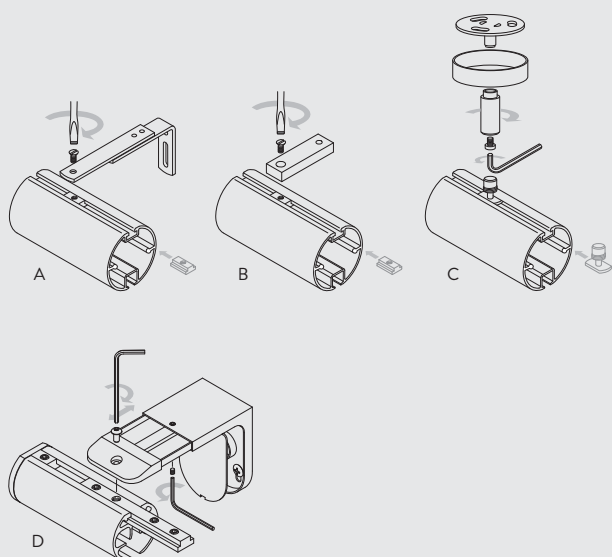

- A: Using adjustable bracket set 11209
- B: Using ceiling support 6138P
- C: Using top fix bracket 0335
- D: Using maxi adjustable bracket 0334

All 50mm Metropole are supplied with Maxi bracket 0334 as standard unless otherwise specified.

6160M

## Fitting Options

### Wall fix with adjustable brackets 11209

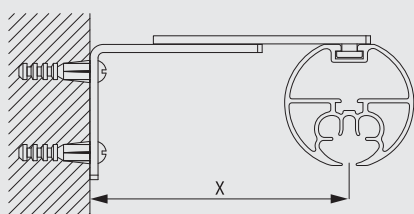

	X (mm)
11209	80-100

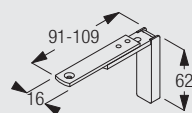

11209  
Smart Fix with  
extension arm set

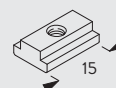

6141  
Track insert (uses  
screw 0798)

### Wall fix with Smart Fix 11206-11208

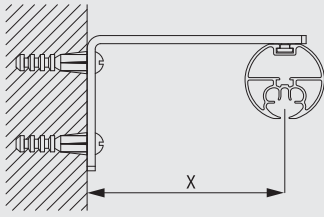

	X (mm)
11206	33-51
11207	53-71
11208	73-91

11206  
Smart Fix, 60 mm  
with slot set

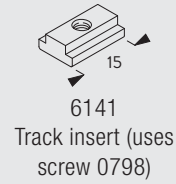

Brackets feature slot for screw M4x8

### Ceiling fix with 6138P2

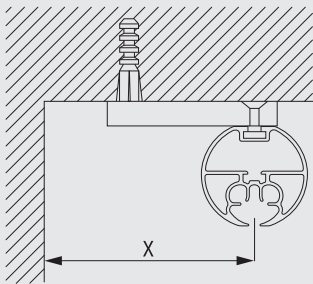

	X (mm)
6138P2	80

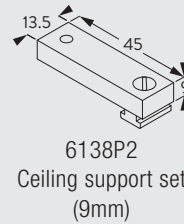

The final distances may be outside of the recommendations above depending on curtain make-up and any obstructions.

### Ceiling fix with top fix bracket 0335

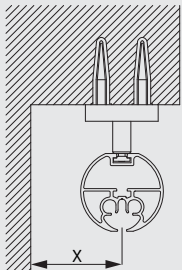

	X (mm)
0335	50

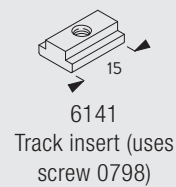
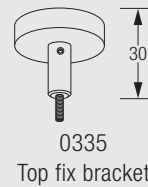

6160M

The final distances may be outside of the recommendations above depending on curtain make-up and any obstructions.

### Wall fix with maxi adjustable bracket 0334

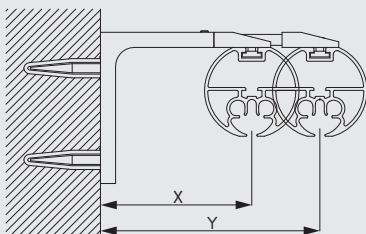

X (mm)	Y (mm)
80	100

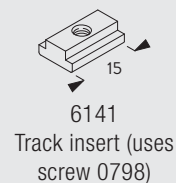



## Celing fix with top fix bracket 0335

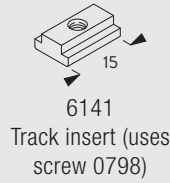
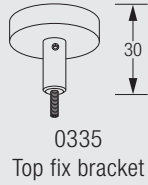
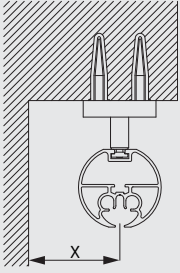

## Wall fitting with Square Smart Fix with slot 11216-11218

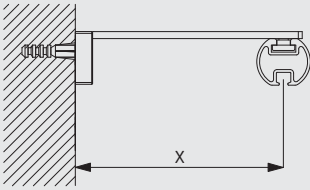

	X (mm)
11216	33-51
11217	53-71
11218	73-91

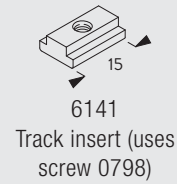
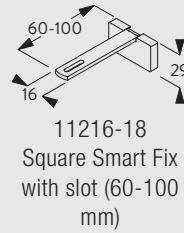

Brackets feature slot for screw M4x8

## Standard Accessories

### Parts

0334	Maxi adjustable bracket		0347	Cording set (50mm)	
0350	Flush endcap (50mm)		0701	Profile 50mm (corded)	
3091	Cord		6065	Twist eye endstop	
6086	Spring stop		6143	Glider 6144 in strip form	
6784	Machine screw (for 6141 insert)		10400	Safety Cord Retainer	

6160M

## Optional Accessories

### Parts

0315	Fused barrel (50mm)		0327	Fused ball (50mm)	
0335	Top fix bracket		0630	Groove Cylinder (50mm)	

0630	Groove Cylinder (50mm)		0697	Strata (50mm)	
0717	Ball end finial (50mm pole)		0717	Ball end finial (50mm pole)	
0718	Spear finial (50mm pole)		0898	Crystal Square (50mm)	
0898	Crystal Square (50mm)		0899	Crystal Cylinder (50mm)	
0899	Crystal Cylinder (50mm)		6007	Endstop	
6283	Roller glider		11206	Smart Fix, 60 mm with slot set	
11207	Smart Fix, 80 mm with slot set		11208	Smart Fix, 100 mm with slot set	
11209	Smart Fix with extension arm set		11216	Square Smart Fix, 60 mm with slot set	
11217	Square Smart Fix, 80 mm with slot set		11218	Square Smart Fix, 100 mm with slot set	
6138P2	Ceiling support set (9mm)				

## Sets

6160M	0646	Intermediate pulley, containing:	0700	Profile 50mm	1	
			0645	Intermediate pulley cover	1	
			3810	Pulley	2	
			6164	Clamping piece	1	
			6169	Holder	1	

## Wave Accessories

2216	Cord		3582	Hook	
6007	Endstop		6315	Pilot runner	

6345	Wave glider cord (60mm)		6346	Wave glider cord (80mm)	
6349	Curtain tape		6363	Top hemming tape	
6364	Extension		6365	Hanger	
6383	Limit stop		10075	Lead weight 50 gr/m	
10076	Fabric weight		6098W	Wave roller glider cord (80mm)	

## Useful Measurements

6063	Metal overlap arm	
------	-------------------	--

6160M

[www.silentgliss.co.uk](http://www.silentgliss.co.uk)  
[www.silentglissglobal.com](http://www.silentglissglobal.com)

Silent Gliss Ltd  
Pyramid Business Park  
Poorhole Lane  
Broadstairs  
Kent  
CT10 2PT  
Great Britain

Tel: +44 (0) 1843 863571  
Fax: +44 (0) 1843 864503  
[info@silentgliss.co.uk](mailto:info@silentgliss.co.uk)

Silent Gliss Global Ltd  
Pyramid Business Park  
Poorhole Lane  
Broadstairs  
Kent  
CT10 2PT  
Great Britain

Tel: +44 (0) 1843 874250  
Fax: +44 (0) 1843 874457  
[info@silentglissglobal.com](mailto:info@silentglissglobal.com)